

Accessories Specification

CLS-BG1313

—CLS series



Indoor

【Basic Parameters】

- Material: AL6063-T5,spraying surface/anodizing
- Coating: Iron Grey
- Length: 2500mm[98.43"]
customizable(Other lengths on request)
- Application: Indoor
- Installation: Mounted
- IP grade: IP20
- Warranty: 5 years

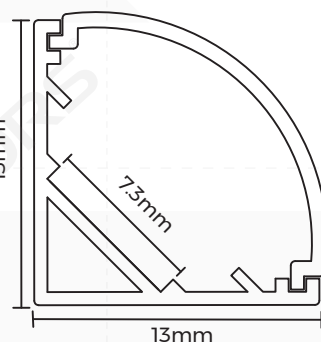

【Luminaire Parameters】

| Version | Model | Length | Input Voltage (V) | Max. Current (A/m) | Type Power (W/m) | Max. Power (W/m) | CRI | CCT | Lumen (LM/m) |
|---------|------------|--------------------|-------------------|--------------------|-------------------|--------------------|-----|-------|-------------------|
| Normal | CLS-BC1313 | 1000mm (3.28ft) | 24 | 0.4 (0.12A/ft) | 9.6 (2.93W/ft) | 10.6 (3.23W/ft) | >90 | 2300K | 690 (210LM/ft) |
| | | | | | | | | 2700K | 710 (216LM/ft) |
| | | | | | | | | 3000K | 740 (225LM/ft) |
| | | | | | | | | 3500K | 750 (228LM/ft) |
| | | | | | | | | 4000K | 760 (231LM/ft) |
| | | | | | | | | 6000K | 730 (222LM/ft) |

Note:

- 1.The above parameters were tested based on 1M [3.28'] standard product and C6160-24V-7mm,Ra90,4000K light source;
- 2.luminous flux is allowed to have a ±15% error range;
- 3.The above parameters are typical values.
- 4.We assure you of consistent color spraying surface within the same batch.However, please be aware that we cannot guarantee color matching across different batches due to silver anodized process.

[Optical Parameter]

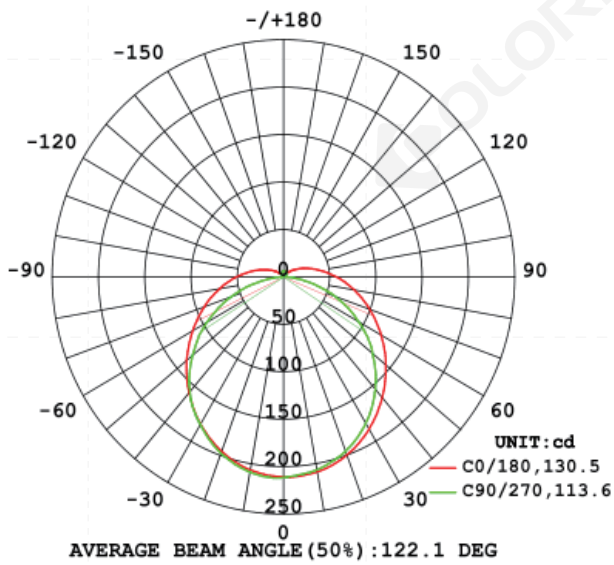

Luminous intensity distribution diagram

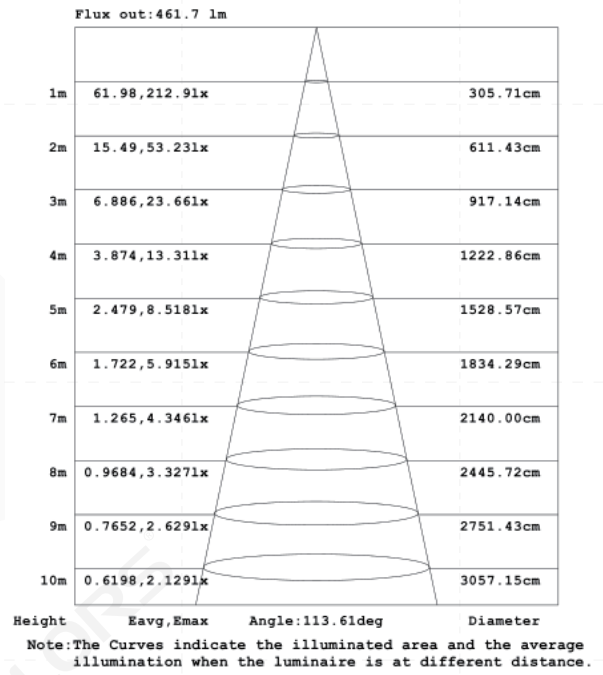

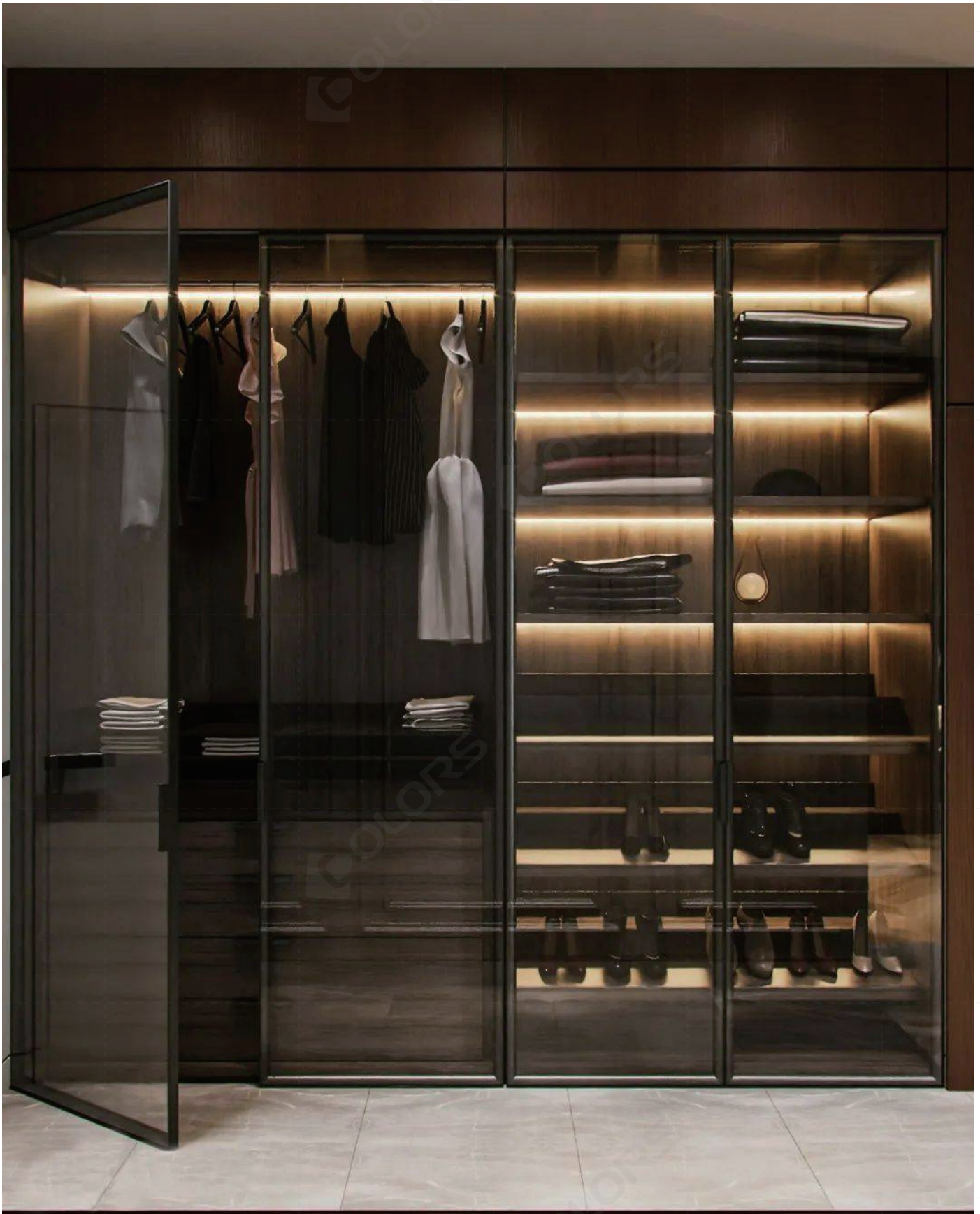

AAI Figure

[Application]

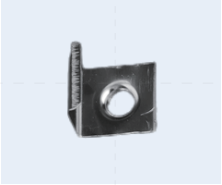
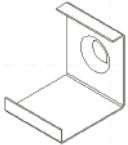
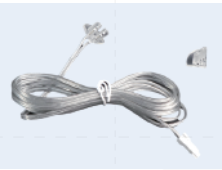
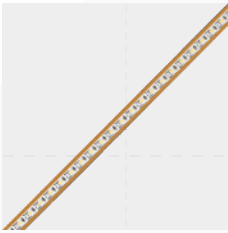
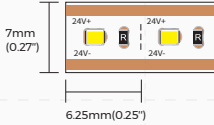

[Product Accessories Information]

| Picture | Section size | Name | Description | Model | Note |
|--|---|----------------|--|----------------|------|
|  |  | Profile | Material: AL6063-T5 Surface processing: Anodizing Size: L2500*W12*H10mm [Inch size: L98.425"*W0.47"*H0.39"] | GLS-BG1313 | / |
|  |  | Clip | Size: 17*10*8.3mm [Inch size: L0.66"*W0.22"*H0.33"] | CLS-BG1313-CLP | / |
|  | / | End caps | Wire: L1800mm*22AWG 1pcs cap with wire+1pcs cap no wire | CLS-BG1313-EC | / |
|  |  | Flexible Strip | Material: SMD CCT: 2300/2700/3000/3500/4000/ 6000K CRI>90; Voltage: 24V; Power: 9.6W/M [2.9W/ft]; Lumen: 1265LM/M [385LM/ft]; Width: 7mm [0.27"]; Bend diameter: >60mm [2.36"]; Minimum cutting unit: 6.25mm [0.25"]; | C6160-24V-7mm | / |

[Packing]

| Model | Modes of packing | Quantity /box | Quantity /carton | NW /carton/(kg) | Carton (kg) | GW /carton/(kg) | Size (mm/carton) |
|----------------------|------------------|---------------|------------------|-----------------|-------------|-----------------|------------------------------------|
| CLS-BG1313FDXIGX2500 | Paper box | / | 12 | 2.4 | 9.1 | 12.5 | 2680*125*115 [105.5"*4.9"*4.5"] |

[Attentions]

1. Non-professionals are prohibited from installing, disassembling and repairing the product.
2. Avoid scratching, distortion and irregular bending of the product during installation; otherwise it may cause irreparable damage to the product.
3. Please use professional cutting tools when cutting
4. Do not use any acid or alkaline adhesive to fix products
5. The product is only suitable for indoor dry places, can not be used in outdoor, seaside or wet environment.
6. PC features: Each 10°C rise or drop will make diffuser extend or shrink 0.8mm/m[0.01"/ft], please confirm before processing and use